

1. General Requirements

This power supply is designed for entry server computer systems. There are five DC outputs: +5V, +12V, -12V, +3.3V & +5VSB and it will provide power to all system components.

2. Input Requirements

2.1 Harmonics

The power supply shall incorporate universal power input active power factor correction, which shall reduce line harmonics in accordance with the EN61000-3-2 and JEIDA MITI standards.

2.2 AC Inlet Connector

The AC input connector shall be an IEC 320 C-14 power inlet.

2.3 AC Input Voltage Specification

The power supply must operate within all specified limits over the following input voltage range. Harmonic distortion of up to 10% THD must not cause the power supply to go out of specified limits.

AC Input Rating

Parameter	Min.	Nom.	Max.	Unit
Vin (Full range)	90-103	103-220	264	Vrms
Vin Frequency	50-60			Hz
Full Load	80%	100%	100%	Watts
AC Current	7-4			Arms

Note: Power factor correction (PFC) >0.95 at full load.

2.4 Efficiency

This model has 87% or greater energy efficient at 20%, 100% utilization, 90% or greater efficiency at 50% utilization, meets innovative USA 80 PLUS Standard for energy and money saving. (All measurements were taken with input voltage at 115V nominal and 60 Hz.)

ErP 2013 ready: Maximum power consumption less than 0.5W in +5Vsb at 45mA. (@230Vac).

2.5 AC Inrush Current

Maximum inrush current from power-on (with power on at any point on the AC sine) and including, but not limited to, three line cycles, shall be limited to a level below the surge rating of the input line cord, AC switch if present, bridge rectifier, fuse, and EMI filter components. Repetitive ON/OFF

cycling of the AC input voltage should not damage the power supply or cause the input fuse to blow. 3. DC Output

3. DC Output

3.1 Voltage /Current

Output Voltage	Minimum Load	Maximum Load	Load Reg.	Cross Reg.	Line Reg.	Ripple & Noise
+3.3V	0.1A	18A	±5%	±5%	±1%	50mV p.p
+5V	0.2A	15A	±5%	±5%	±1%	50 mV p.p
+12V	0.15A	41.7A	±5%	±5%	±1%	120 mV p.p
-12V	0A	0.3A	±10%	±10%	±1%	120 mV p.p
+5V _{SB}	0A	2.5A	±5%	±5%	±1%	50mV p.p

Note:

- A. Maximum continuous total DC output power should not exceed 500W.
- B. Peak total DC output power should not exceed 600W.
- C. Peak power and current loading shall be supported for a minimum of 10 seconds.
- D. Combined 3.3V and 5V power shall not exceed 90W.
- E. Ripple and noise measurements shall be made under all specified load conditions through a single pole low pass filter with 20MHz cutoff frequency. A 0.1uF ceramic disk capacitors in parallel with a 10uF tantalum are placed at the point of measurement. See Figure 1.

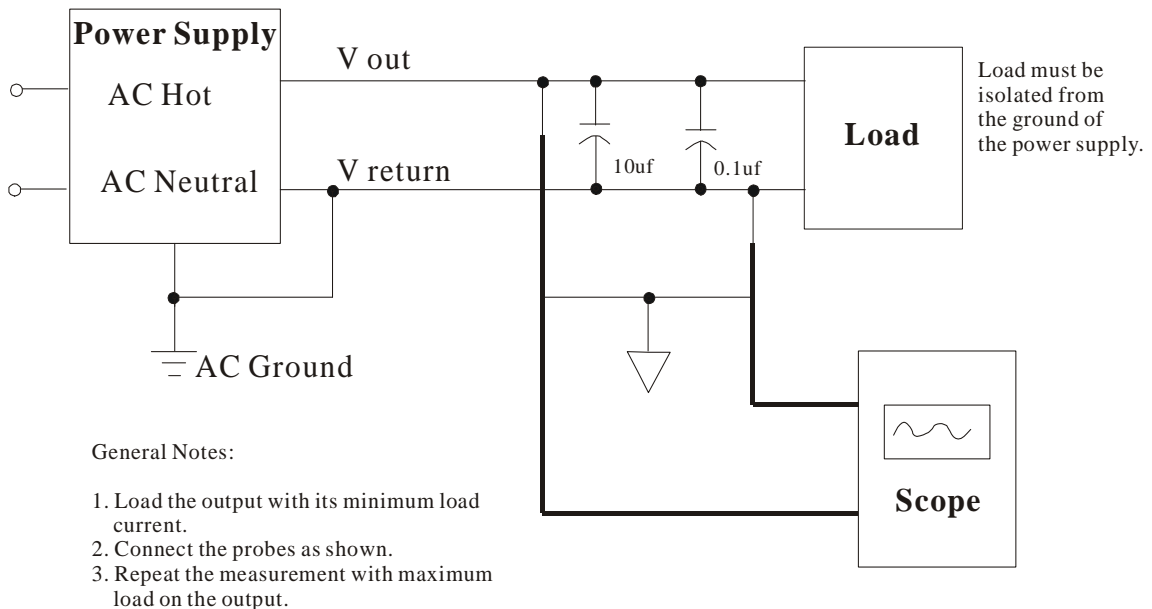

Figure 1. Differential Noise Test Setup

3.2 DC Connectors

3.2.1 Baseboard Power Connector

Connector housing: 24(20+4)-Pin WST P/N: P20-I42002K11B + P4-I42002K11B or equivalent

Pin and Cable Color Assignment

Pin	Signal	Cable Color	Pin	Signal	Cable Color
1	+3.3VDC	Orange	11	+3.3VDC	Orange
2	+3.3VDC	Orange	12	-12VDC	Blue
3	COM	Black	13	COM	Black
4	+5VDC	Red	14	PS_ON	Green
5	COM	Black	15	COM	Black
6	+5VDC	Red	16	COM	Black
7	COM	Black	17	COM	Black
8	PWR OK	Gray	18	Reserved	N.C.
9	+5VSB	Purple	19	+5VDC	Red
10	+12VDC	Yellow	20	+5VDC	Red
1	+12VDC	Yellow	3	+5VDC	Red
2	+3.3VDC	Orange	4	COM	Black

3.2.2 PCI-E Power Connector for High Power Graphics Cards

For high-powered graphics cards an additional power connector to the baseboard may be needed. This connector supplies additional +12V power for the higher power level graphics cards used in workstation applications.

Connector housing: 8-(6+2) Pin WST: P6-I42002K13A&P2-I42002K13A or equivalent

Pin and Cable Color Assignment

Pin	Signal	Cable Color	Pin	Signal	Cable Color
1	+12VDC	Yellow	5	COM	Black
2	+12VDC	Yellow	6	COM	Black
3	+12VDC	Yellow	7	COM	Black
4	COM	Black	8	COM	Black

3.2.3 Processor Power Connector

Connector housing: 8(4+4) Pin WST P/N: P4-I42002K3B&P4-I42002K4B or equivalent

Pin and Cable Color Assignment

Pin	Signal	Cable Color	Pin	Signal	Cable Color
1	COM	Black	5	+12VDC	Yellow
2	COM	Black	6	+12VDC	Yellow
3	COM	Black	7	+12VDC	Yellow
4	COM	Black	8	+12VDC	Yellow

3.2.4 Peripheral Power Connector

Connector housing: Yestone P/N: P01001-K-01 or P4-A10202 or equivalent

Pin and Cable Color Assignment

Pin	Signal	Cable Color
1	+12VDC	Yellow
2	COM	Black
3	COM	Black
4	+5VDC	Red

3.2.5 Floppy Power Connector

Connector housing: WST P/N: I25001 or equivalent

Pin and Cable Color Assignment

Pin	Signal	Cable Color
1	+5VDC	Red
2	COM	Black
3	COM	Black
4	+12VDC	Yellow

3.2.6 Serial ATA Power Connector

Connector housing: WST P/N: P5-I12702T00 or P5-I12702T00 or equivalent.

Pin and Cable Color Assignment

Pin	Signal	Cable Color
1	+3.3VDC	Orange
2	COM	Black
3	+5VDC	Red
4	COM	Black
5	+12VDC	Yellow

Note: Output cables may be different in designated model on the length, connector type and/or quantity.

3.3 Remote On/Off Control

The power supply DC outputs (with the exception of +5 VSB which is always available) are enabled with an active-low, TTL-compatible signal (“PS-ON”), When PS-ON is pulled to TTL low, the DC outputs are enabled. When PS-ON is pulled to TTL high or open-circuited, the DC outputs are disabled. PS-ON may be active by either electronic means or a mechanical switch.

3.4 Rise Time

The output voltage shall rise from 10% to within regulation limits within 0.1 to 25ms.

3.5 Overshoot at Turn-On/Turn-Off

The output voltage overshoot upon the application or removal of the input voltage under the conditions specified in section 2.3 shall less than 10% above the nominal voltage.

3.6 Hold-up Time

The power supply should maintain output regulations per Table1 despite a loss of input power at the low-end nominal range-115Vac / 47Hz or 230Vac / 47Hz - at 75% continuous output load as applicable for a minimum of 17ms.

3.7 Power Good Signal

A “power good” signal is asserted by the supply to indicate that the +5VDC output is within regulation limits.

Power Good Signal Characteristics:

Signal Type:	+5V TTL compatible
Logic level low:	<0.4V while sinking 4mA
Logic level high:	Between 2.4V and 5V output while sourcing 200 μ A
High state impedance:	1K Ω (from output to common)
POK delay:	100-500ms
Power fall warning time:	1ms minimum

4. Protection Circuits

4.1 Over Voltage Protection

The power supply over voltage protection shall be locally sensed. The power supply shall shutdown and latch off after an over voltage condition occurs. This latch shall be cleared by toggling the PSON# signal or by an AC power interruption. The below enclosed table contains over voltage limits. The values are measured at the output of the power supply’s connector. The voltage shall never exceed the maximum levels when measured at the power pins of the power supply connector during any single point of fail. The voltage shall never trip any lower than the minimum levels when measured at the power pins of the power supply connector.

Output Voltage	MIN(V)	MAX(V)
+3.3V	3.76	4.3
+5V	5.5	7.0

+12V	13.4	15.6
------	------	------

4.2 Over Current Protection (OCP)

The power supply shall have current limit to prevent the +3.3V, +5V, and +12V outputs from exceeding the values shown in below enclosed table. If the current limits are exceeded the power supply shall shutdown and latch off. The latch will be cleared by toggling the PSON# signal or by an AC power interruption. The power supply shall not be damaged from repeated power cycling in this condition. -12V and 5VsB shall be protected under over current or shorted conditions so that no damage can occur to the power supply. All outputs shall be protected so that on damage occurs to the power supply under a shorted output condition.

Voltage	Over Current Limit
+3.3V	25A minimum, 40A maximum
+5V	25A minimum, 40A maximum
+12V	49A minimum, 67A maximum

4.3 Short Circuit Protection

A short circuit on any DC output will cause the power to latch. The power supply will withstand a continuous short circuit to the output without damage or overshoot to the unit. The +5VSB can be shorted indefinitely and will recover automatically when the short is removed.

4.4 Over Power Protection (OPP)

The power supply shall go shutdown when the total output load is over 120-160% of rating.

5 Physical Environment

5.1 Operation Conditions

The power supply shall be capable of continuous operation and meet all electrical specification without need for adjustment when subjected to the following environmental conditions:

	Temp. vs. Load Condition	Humidity
Operation	0~30°C@Full Load	10%~90%RH
	40°C@80% Rated Load	
Storage	-20°C~80°C	5%~90%RH

* No degradation of the power supply shall occur during shipping or storage at the specified condition.

5.2 Shocks and Vibration

The power supply will withstand the following imposed conditions without experiencing non-recoverable failure or deviation from specified output characteristics.

6. Regulatory Compliance

6.1 Safety Requirements

-

6.2 Dielectric Strength

Primary to Secondary: 1500 VAC for 1~3 seconds.

Primary to Frame Ground: 1500 VAC for 1~3 seconds.

6.3 Insulation Resistance

Primary to Secondary: 20 Meg. ohm Minimum.

Primary to Frame Ground: 20 Meg. ohm Minimum.

6.4 Ground Leakage Current

The power supply ground leakage current shall be less than 3.5mA.

The power supply grounding continuity shall be less than 100mΩ when the test current is at 25A.

7. Reliability

The power supply has a minimum predicted MTBF (MIL-STD-217E) of 100,000 hours of conditions operation at 25°C, maximum-output load, and nominal AC input voltage.

APPROVED BY: _____ CHECKED BY: _____ PREPARED BY: _____